

# QUADROR™ 03

design: Dror, 2015



Top in tamburato di abete impiallacciato in frassino, tinto ad olio. Rinforzi longitudinali interni in metallo. Gambe QuaDror™ in frassino massello tinto ad olio.

Top in spruce panelling with ash veneer finished in oil-based stain. Lengthwise internal reinforcements in metal. QuaDror™ legs in solid ash with oil-based stain.

Plateau en nid d'abeilles sapin contre-plaqué en frêne teinté à l'huile. Renforcements internes longitudinaux en métal. Pieds QuaDror™ en frêne massif teinté à l'huile.

Aufsatz aus Tannenhohlkern furniert mit lackierter Esche. Innere Längsstützen aus Metall. QuaDror™ Beine aus massiver, lackierter Esche.

Parte superior de estructura alveolar contrachapado en fresno teñida con aceite. Refuerzos longitudinales internos de metal. Patas QuaDror™ de madera de fresno teñida con aceite.

Il top può essere realizzato su misura fino a un massimo di 420 cm (lunghezza) e 135 cm (larghezza). Per una quotazione scrivi a ordini@horm-orizzonti.com

The top can be made to measure to a maximum of 420cm (length) and 135cm (width). For a quote please write to orders@horm-orizzonti.com



Le plateau peut être réalisé sur mesure jusqu'à un maximum de 420 cm (longueur) et 135 cm (largeur). Pour un devis, écrivez à orders@horm-orizzonti.com

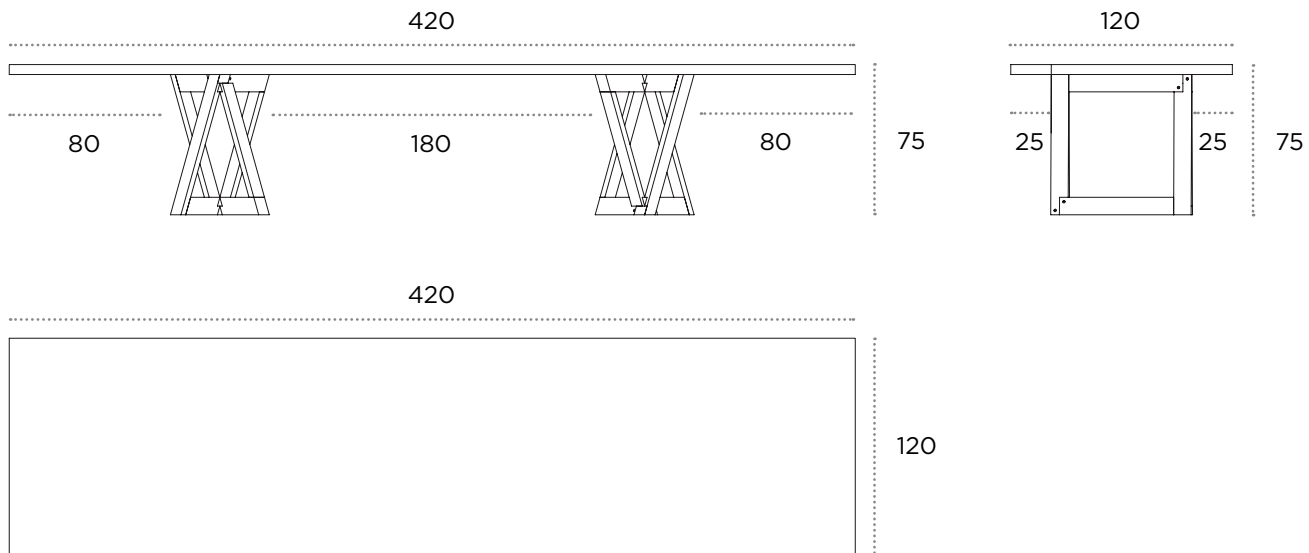

Der Aufsatz kann nach Maß hergestellt werden, die Länge kann maximal 420 cm, die Breite 135 cm sein. Für einen Kostenvoranschlag schreiben Sie an orders@horm-orizzonti.com









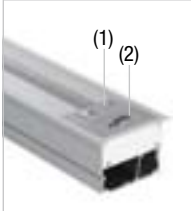





La parte superior se puede desarmar para medir hasta un máximo de 420 cm (longitud), y 135 cm (ancho). Para un presupuesto, escriba a orders@horm-orizzonti.com



<b>GAMBE E PIANO</b> <b>FEET AND TOP</b> <b>PIEDS ET PLAN</b> <b>FÜSSE UND PLATTE</b> <b>PATAS Y TOP</b>	<b>frassino imbiancato</b> <b>whitened ash</b> <b>frêne blanchi</b> <b>weiss Esche</b> <b>fresno blanqueada</b>	<b>frassino tinto moca</b> <b>mocha-stained ash</b> <b>frêne moka</b> <b>Mokka Esche</b> <b>fresno moca</b>
		
cm 420 x 120 x 75H 165.3" x 47.2" x 29.4"H	QD420LI	QD420LM

ACCESSORI	ACCESSORIES	ACCESSOIRES	ZUBEHOER	ACESSORIOS
<b>BINARIO ELETTRIFICATO</b>	<b>POWER TRACK</b>	<b>RAIL ÉLECTRIFIÉ</b>	<b>ELEKTRISCHE ANSCHLUSSLEISTE</b>	<b>CARRIL ELECTRIFICADO</b>
Voltage: 250 V single phase - Current: maximum 32 A at 25° C ambient temperature - Frequency: 50/60 Hertz - Material: Aluminum - Insulation material: Polycarbonate Built in dimensions: 70 mm x 57 mm (width x depth) - Weight: 2.6 kg (per meter)				
lunghezza / length n. max adattatori / max no. adaptors	1747 mm 15	Il prezzo include 8 tappi The price includes 8 caps Le prix comprend 8 bouchons Der Preis umfasst 8 Verschlüsse El precio incluye 8 tapones		
codice / code	EUBIQ-RH1-1787			

CONNETTORI	CONNECTORS	CONNECTEURS	KONNEKTOREN	CONECTORES
	 (1)	 (2)		
tipo / type	Supporto voce e dati Voice-data support	VGA gender changer		
codice / code	5501-0030-0004	5561-0030-0004		

ADATTATORI	ADAPTERS	ADAPTATEURS	ADAPTER	ADAPTADORES			
							
modello / model corrente / current	Italia 10/16A	Schuko 16A	International (*) 13A	UK 13A	France 16A	USA 15A	Japan 15A
codice / code	UAUT 149-TT	UAUE 75-TT	UAUX 121-TT	UAUB 74-TT	UAUF 109-TT	UAUI 124-TT	UAUJ 123-TT
							
paese / country corrente / current	Japan - Euro 16A	India - Combo 6/16A	India 16A	South Africa 16A	Australia 10A	China 10A	USB
codice / code	UAUJ 110-TT	UAUI 113-TT	UAUI 111-TT	UAUI 114-TT	UAUA121-TT	UAUA126-TT	UACX 68-TT

(\*) EURO2, Australia, Cina, India, US, Giappone, UK, Schuko (senza terra)